

# EXCALIBUR II

Instruction Manual

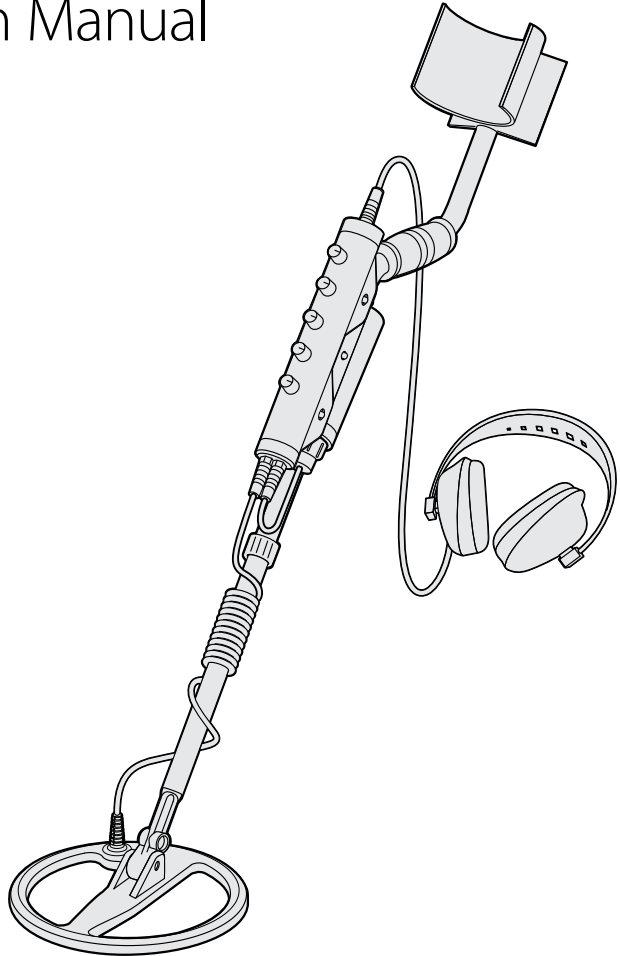

# Quick Start

## **Discriminate Mode:** *(For detecting non-ferrous metals)*

- 1 Ensure that the battery pack is fully charged. (pg. 14)
- 2 Set the mode switch to Disc (Discriminate). (pg. 27)
- 3 Turn the detector 'On' by turning the Threshold control clockwise until it 'clicks'. Continue turning until the audio tone becomes 'just' audible. (pg. 22)
- 4 Set the desired position of the Discriminate control. (pg. 28)
- 5 Set the Sensitivity control to Auto or at the maximum manual setting without electrical interference. (pg. 25)

**You are now ready to start searching.**



## **Pinpoint/All Metals Mode:** *(For detecting all types of metals)*

- 1 Ensure that the battery pack is fully charged. (pg. 14)
- 2 Set the mode switch to Pinpoint/All Metals. (pg. 27)
- 3 Turn the detector 'On' by turning the Threshold control clockwise until it 'clicks'. Continue turning until the audio tone becomes 'just' audible. (pg. 22)
- 4 Set the Sensitivity control to Auto or at the maximum manual setting without electrical interference. (pg. 25)

**You are now ready to start searching.**



# Congratulations on purchasing the Minelab Excalibur II

Metal detecting is a fascinating and rewarding activity enjoyed by people all over the world. By getting to know your Excalibur II, you may become one of the many who find gold and valuable treasure.

The Excalibur II is an amphibious machine performing as well on land and the beach as it does underwater. You can be confident in its ability to penetrate deeply and discriminate accurately underwater, at depths of up to 66 m (200 ft).

With Minelab's unique Broad Band Spectrum (BBS) multi-frequency technology, this machine transmits at 17 individual frequencies simultaneously to give you the depth, sensitivity and accuracy that you need.

While being extremely advanced, the Excalibur II is also an easy-to-use detector having very few controls that require adjustment after they have been set. The Excalibur II will always operate at maximum performance without the need to ground balance manually.

The Excalibur II includes a light slimline coil to reduce detecting fatigue (you can choose 8" or 10" as standard), a rechargeable NiMH battery pack to provide you with maximum detecting time and a fluorescent skidplate to guide you in poor visibility wading and underwater conditions.

If you have any questions or comments regarding the Excalibur II or any other Minelab product, then please feel free to contact us via your local Authorised Minelab Dealer or write to us directly.

**Minelab wishes you every success as you experience the excitement of discovery.**

# 2 Contents

Quick Start	Back Cover
How Metal Detectors Work	4
BBS Technology	5
List of Parts	6
Assembly	7
Adjusting the Detector for Comfortable Use	12
Charging the Battery Pack	14
Detecting Basics	16
Common Terms	17
Control Panel	18
Turning the Detector On	19
A Detecting Exercise	20

Threshold / Adjusting the Background Audio Level	22
Volume / Setting the Volume of Target Signals	24
Sensitivity	25
Identifying Targets	26
Disc or Pinpoint/All Metals / Selecting a Mode	27
Discriminate / Rejecting Unwanted Targets	28
Pinpointing / Locating the Target	30
Recovering the Target	32
Taking Care of Your Detector	34
Taking Care of Your Battery	35
Troubleshooting	36
Technical Specifications	37
Accessories	38
Warranty	39
Service Repair Form	40

# 4 | How Metal Detectors Work

Metal detectors create an electro-magnetic (EM) field, which penetrates the ground. Because metal is conductive it causes a change in this field. The detector senses this change and sends a signal back to the control box, alerting the operator.

Metal detectors can determine the size, shape and composition of metallic objects beneath the coil. Typically, the larger the object, the easier it is to detect.

A metal detector's EM operating frequencies are measured in kilohertz (kHz).

Low frequency EM fields deeply penetrate the ground, but sensitivity to smaller targets is low. High frequency EM fields have less depth, but sensitivity to small targets is high.

The Excalibur II's multiple frequency operation provides the advantages of both.



## Broad Band Spectrum (BBS)

Most detectors on the market operate on a single or dual frequency, ranging from 1 to 70 (kHz).

Although this technology has served the industry well for years, Minelab has found a frequency which works well in one area can often offer only marginal performance when used in another location. Ground mineralisation, trash content and target size all have an effect on how effective a detector transmitting a single frequency will operate.

The Broad Band Spectrum (BBS) circuit automatically transmits 17 frequencies simultaneously. This increased frequency range means the signal received from the detector coil is analysed from a wide range of responses.

BBS technology allows the Excalibur II to locate targets in the most challenging areas of high mineralisation and trash, on the land, beach and underwater.

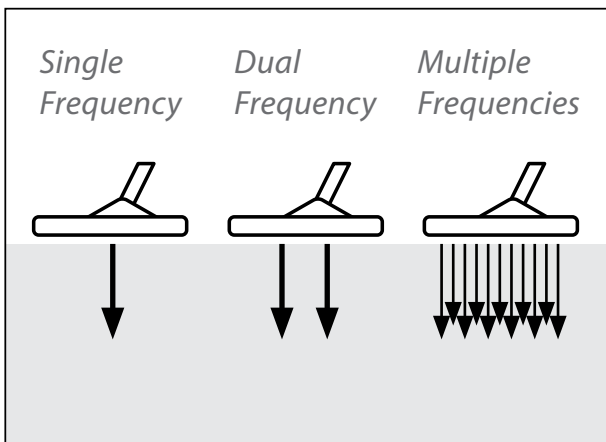

# 6 List of Parts

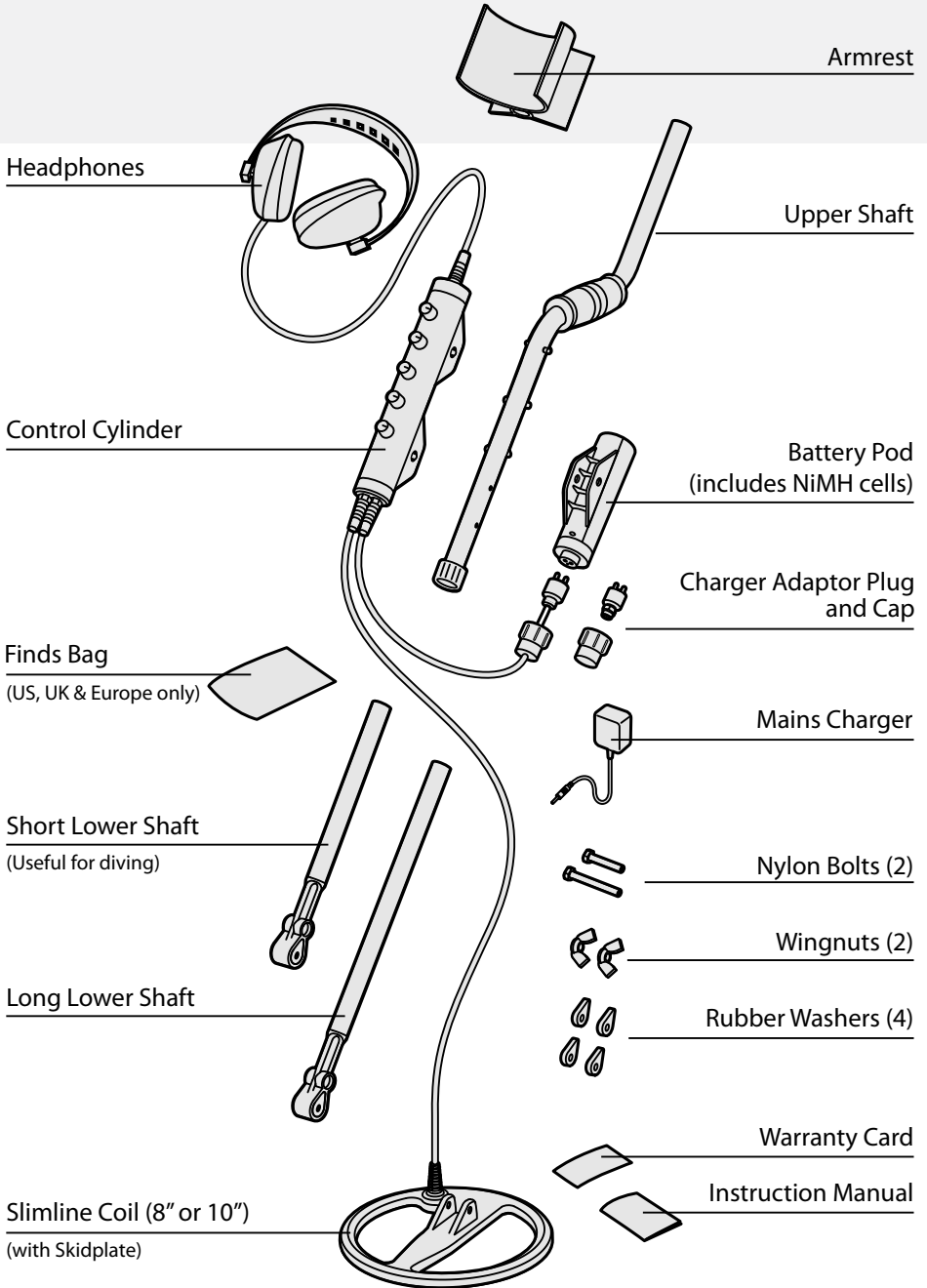



## Attaching the Armrest to the Upper Shaft:

If not already bolted to the upper shaft:

- 1 Ensure that the cup of the armrest is pointing in the same direction as the handle. Slide the armrest onto the end of the upper shaft aligning the shaft and armrest holes.
- 2 Insert the short bolt through the armrest and upper shaft holes.
- 3 Fasten the wing-nut onto the bolt.

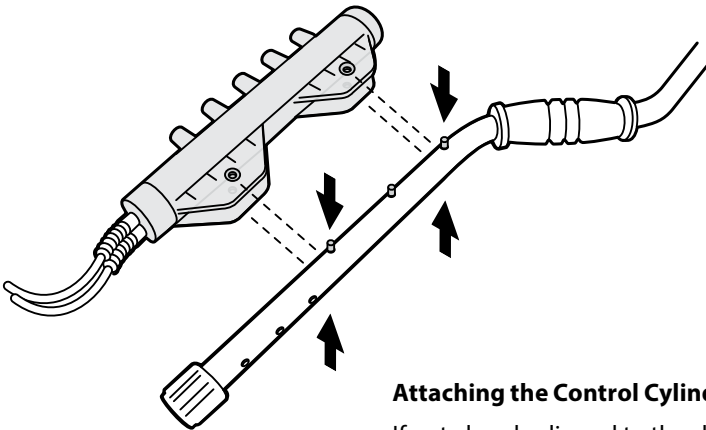
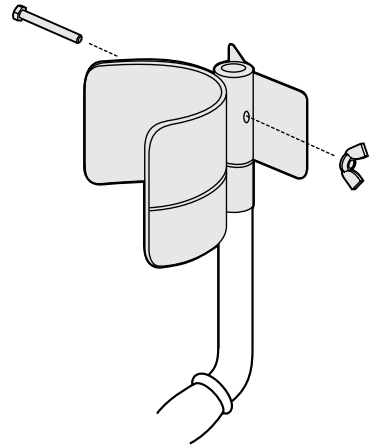

## Attaching the Control Cylinder to the Upper shaft:

If not already clipped to the shaft:

- 1 Compress the lower spring loaded pin of the upper shaft.
- 2 Ensure that the coil cable of the control cylinder is pointing downwards. Slide the control cylinder onto the upper shaft until both pins are compressed and they reach the adjustment holes. The pins will spring out and clip into place.

# 8 Assembly

## **Side-Mount Upper Shaft** *(Available as an accessory)*

The alternate position of the pins allows the control cylinder and battery to be attached on the side of the shaft. The side-mount position allows you to detect close to the ground and reduces the resistance when wading or detecting underwater.

The control cylinder is attached to the side-mount shaft using the same procedure as for the standard upper shaft.

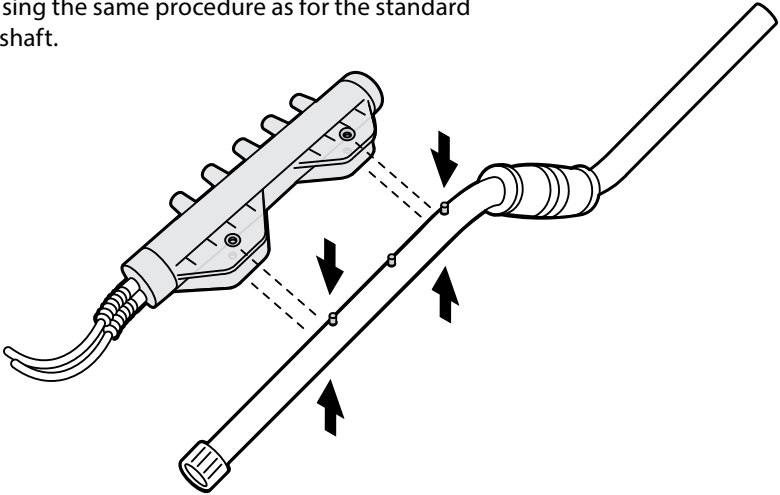

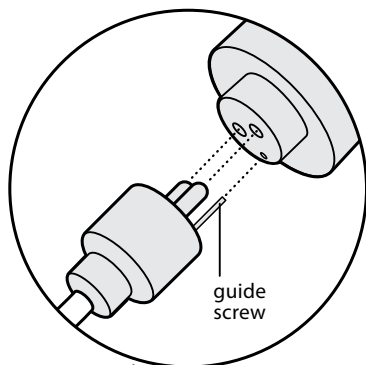

### Connecting the Battery Pack to the Upper Shaft:

- 1 Connect the cable from the control cylinder to the battery pack, using the guide screw to align the battery contacts correctly.
- 2 Firmly tighten the water exclusion seal by hand. This seal must be firmly tightened to ensure that no water enters the connection. Water in the connection can cause instability and corrosion of contacts which will void the warranty.

*Minelab applies a silicone grease to the battery connections during the manufacturing process. This may need to be reapplied over time as part of your routine detector maintenance. (pg. 35)*

If the battery is not already clipped to the shaft:

- 3 Compress the middle spring loaded pin of the upper shaft.
- 4 Ensure that the battery cable is pointing down. Slide the battery onto the bottom of the shaft until the pin reaches the adjustment holes. The pin will spring out and clip into place.

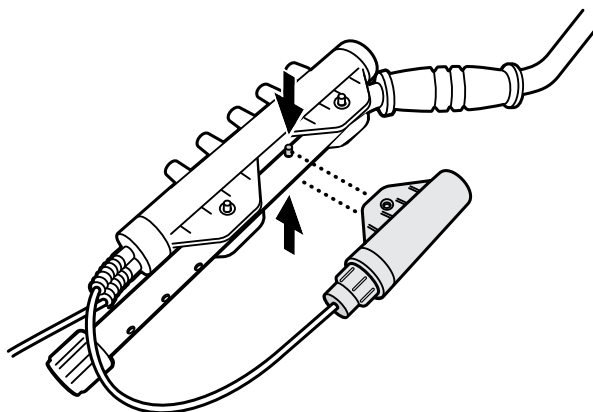
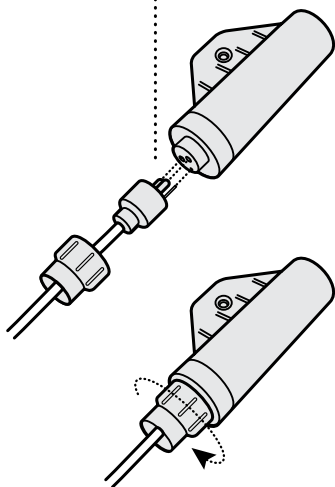

# 10 Assembly

## Attaching the Lower Shaft to the Coil:

The short lower shaft is most commonly used for underwater detecting, while the long lower shaft is mostly used for land detecting. Both the long and short lower shafts are attached in the same way.

- 1 Plug the two rubber washers into the holes on either side of the lower shaft.
- 2 Ensure that the spring loaded pin of the lower shaft is pointing to the left. Slide the lower shaft into the bracket on top of the coil.
- 3 Insert the long bolt through the lower shaft and the bracket on top of the coil. Fasten with the nut provided, being careful not to damage the thread of the nut by over-tightening. This may need to be loosened to adjust the coil to a comfortable detecting angle.

*The coil cable is directly wired into the coil and is not removable. Any attempt to disconnect this cable will void your warranty.*

*If the coil becomes loose over time, the rubber washers may need to be replaced.*

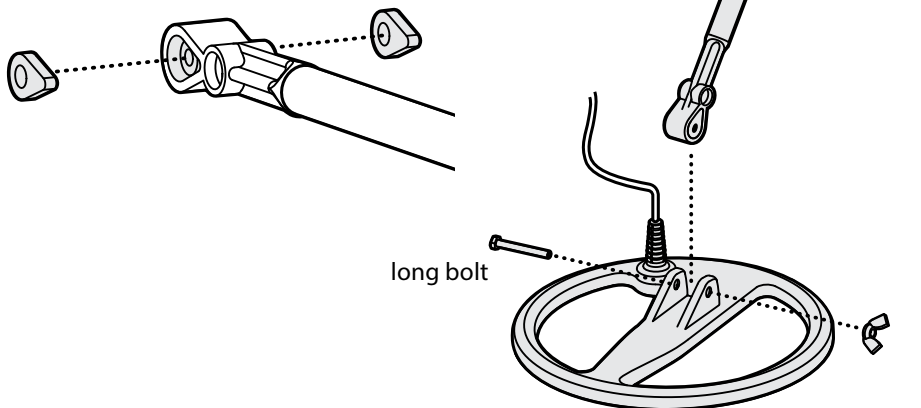

### Winding the Coil Cable:

Wind the coil cable around the lower shaft enough times to take up the slack (try sitting down and rotating the shaft on your knee). Leave enough slack at the bottom of the cable near the coil to allow the angle of the coil to be adjusted while detecting.

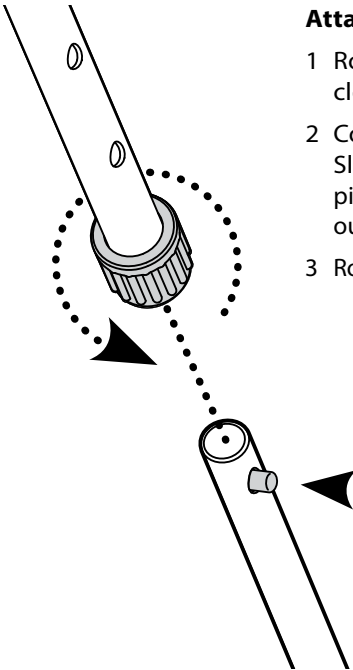

### Attaching the Upper Shaft to the Lower Shaft:

- 1 Rotate the twistlock of the upper shaft counter-clockwise to ensure that it is loosened.
- 2 Compress the spring loaded pin of the lower shaft. Slide the lower shaft into the upper shaft until the pin reaches an adjustment hole. The pin will spring out and clip into place.
- 3 Rotate the twistlock clockwise to tighten it on the shaft.

# 12 Adjusting the Detector for Comfortable Use

For comfortable, long term detecting, it is important that you take the time to adjust the detector correctly.

**Holding the Detector:**  
Grasp the handle of the detector and rest your forearm in the armrest.

## Adjusting the Length of the Lower Shaft:

The correct length of the lower shaft should allow you to swing the coil in front of your body without any uncomfortable stretching or stooping. If the coil is too far from your body it will be difficult to balance and manoeuvre while detecting. If the coil is too close to your body it may detect your digging tool or any other metal that you are carrying, causing confusing sounds.

- 1 Rotate the twistlock of the shafts counter-clockwise to ensure that they are loosened.
- 2 Compress the spring pins of the shafts and move them up or down to suit. Once all shafts are clipped into position, rotate twistlocks clockwise onto the shafts until they are firmly clamped.

## Adjusting the Position of the Armrest:

Align the adjustment holes so your elbow sits just above the back of the armrest and so you can comfortably grip the handle.

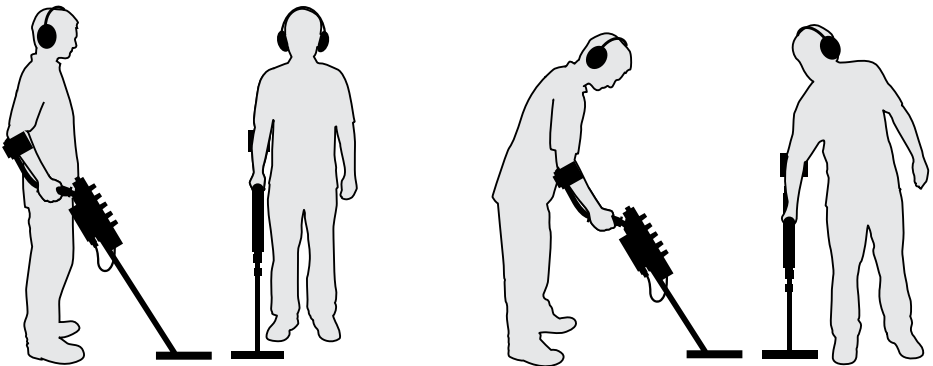

*Shaft is the correct length*



*Shaft is too short*



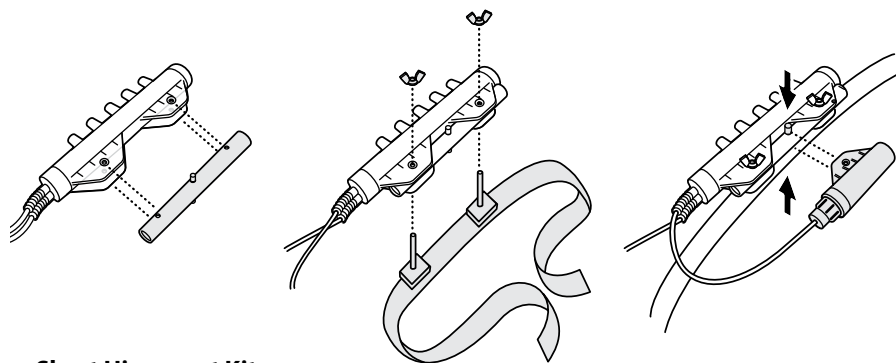

### Short Hipmount Kit (Available as an accessory)

The hipmount kit consists of a short shaft and belt that allows you to wear the control cylinder and battery pack on your waist or over your shoulder. This takes weight off the shaft for a more comfortable detecting session.

- 1 Detach the control cylinder and battery from the main shaft.
- 2 Align the holes of the control cylinder and the hipmount shaft.
- 3 Attach the control cylinder to the shaft with the bolts (attached to the belt) and wingnuts.
- 4 Compress the middle spring loaded pin of the short hipmount shaft.
- 5 Slide the battery onto the shaft until the pin reaches the adjustment hole. The pin will spring out and clip into place.
- 6 Comfortably tighten the belt around your waist.



*Ensure you position the hipmount shaft in a way which does not cause excessive strain on the cables.*

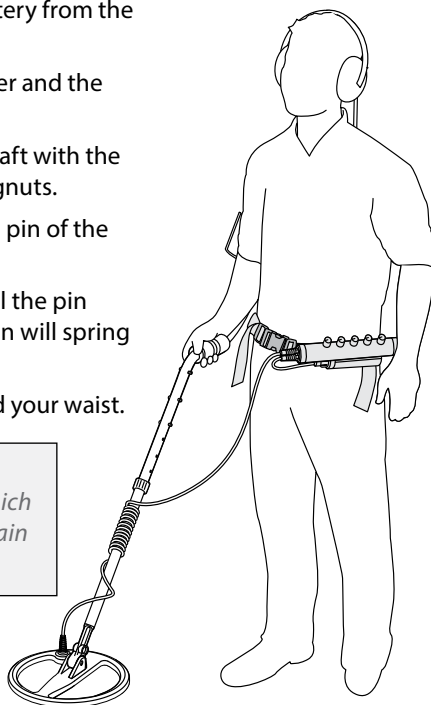

# 14 Charging the Battery Pack

The Excalibur II is supplied with a sealed battery pack which contains 10 NiMH rechargeable cells. This pack has been pressure tested to a depth of 66 m (200 ft) which makes it suitable for both land and underwater detecting.

The batteries can be recharged without having to remove them from the pack .

The Excalibur II is also supplied with an adaptor plug and a mains charger (240 V / 230 V / 110 V). The charger will charge the batteries from local mains (AC) power outlets.

- 1 Unplug the battery cable from the battery pack (you can leave the battery pack on the shaft).
- 2 Connect the charger into the adaptor plug.
- 3 Connect the adaptor plug to the battery pack using the guide screw to align the battery contacts correctly.
- 4 Plug the charger into a power socket. For its first time, allow the battery to charge for at least 4–5 hours to ensure its peak performance while detecting.

A fully charged battery pack should provide you with 14–19 hours of detecting time.

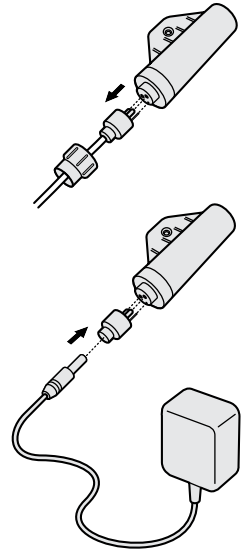

*An extra NiMH battery pack can also be purchased separately as an accessory item.*



## **Battery Charging**

Recommend only charging the batteries indoors and when temperature is below 30°C (86°F) if charging outdoors.



## **Low Battery Alarm**

When the batteries are nearing depletion, the threshold will gradually increase to a loud continuous signal. This tone identifies that the NiMH battery pack needs to be recharged or the alkaline batteries need to be replaced. A fully charged battery pack ensures optimum performance.



### **Alkaline Battery Pack (Available as an accessory)**

The alkaline pack is water resistant but not waterproof so is suitable for land and beach shallow-wading only. This pack is not sealed and must be opened to replace the batteries.

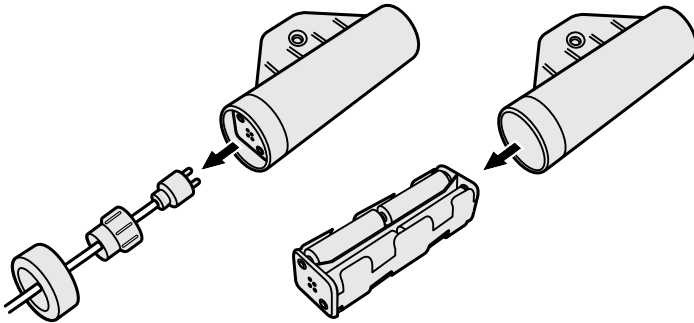

### **Replacing Alkaline Batteries:**

- 1 Ensure that the detector is switched off before opening the alkaline battery pack.
- 2 Remove the cap of the battery pack.
- 3 Remove the battery cell compartment from the battery pack and take out the old batteries.
- 4 Install the new batteries, orientating the positive (+) and negative (-) as shown.
- 5 Replace the compartment and the battery pack cap.

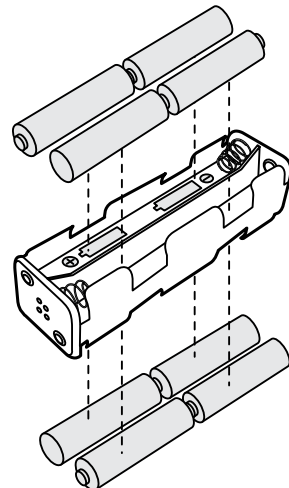

*Always use good quality alkaline batteries.*

*Rechargeable NiMH batteries cannot be used in the Alkaline pack, as they do not provide sufficient voltage.*

# 16 | Detecting Basics

The Excalibur II is a 'motion' detector. This means that the coil must be 'moving' over a target to detect it.

If the coil is held stationary over a target the detector will not give a response.

The Excalibur II will perform at its best when the coil is kept close and parallel to the ground, beach, river/ sea bed at all times. This will increase detection depth, response to small objects and help prevent false signals.

Practise sweeping the coil over the ground in a side-to-side motion, while walking forward slowly. At the end of each sweep slightly overlap the previous sweep to ensure full ground coverage. An average sweep speed is four seconds from left to right to left. If you sweep too fast your discrimination accuracy will suffer and you may miss deep targets. A variation in coil height at the end of each swing may cause confusing sounds and reduce detection depth, so an even, flat sweep is desirable.

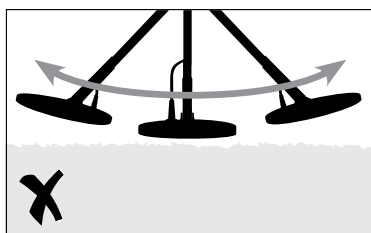
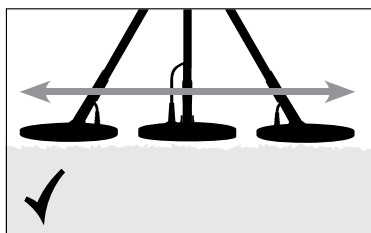
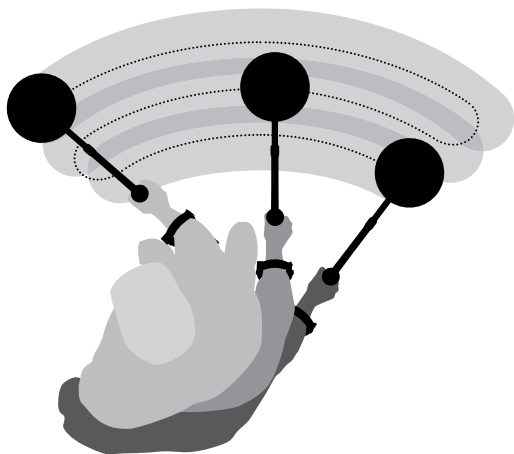

## **Blanking**

When sweeping over a rejected target, the threshold 'blanks' (becomes silent) indicating that a target is located underneath the coil, but has been rejected by you. Blanking is a useful way of distinguishing between desired and undesired targets. *(pg. 29)*

## **Discrimination**

Discrimination is the ability of a metal detector to identify the user's desired target (e.g. jewellery) and eliminate signals from undesirable material (e.g. nails). The Discriminate control allows you reject or 'ignore' certain targets. *(pg. 28)*

## **Electrical Interference**

The detector may also produce sounds when the coil is not over a target. These signals are caused by nearby electromagnetic sources such as power lines and phone towers. *(pg. 19)*

## **Ground Noise**

The detector may also produce various random signals caused by different minerals in the ground, sometimes referred to as false signals. *(pg. 19)*

## **Targets**

Buried metal objects are referred to as targets. Targets are comprised of both ferrous and non-ferrous metals.

## **Target Response (Metal Object Response)**

This is the term given to the change in the volume (and pitch in Disc mode) of the threshold when a target is detected and not discriminated (rejected).

## **Threshold (Background Sound)**

This is the background sound produced by the detector. When a target is detected, the threshold changes in volume (and pitch in Disc mode). Listen to the threshold carefully. Concentration is an important part of detecting. A very deep or small target may only give a minor change to the threshold. *(pg. 22)*

# 18 Control Panel

## Discriminate

Controls which type of targets (metal objects) the detector will reject.

*(pg. 28)*

## Sensitivity

Increases/decreases the detectors response to its environment and to targets. *(pg. 25)*

## Volume

Controls the maximum level of sound emitted by the detector when a target is detected. *(pg. 24)*

## Threshold

Increases/decreases the constant background audio produced by the detector. *(pg. 22)*

This control is also used to turn the detector on/off.

## Disc or Pinpoint/All Metals

The Excalibur II can operate in two different modes. This control allows you to switch between Disc mode and Pinpoint/All Metals mode. *(pg. 27)*



The Discriminate function becomes active when Disc mode is selected.

# Turning the Detector On



The Threshold control is also used to turn the detector on.

Turn the control clockwise until it clicks 'on'.



It is best to only turn the detector on when outdoors and away from sources of electromagnetic interference such as power lines, transmitters, electric fences and phone towers. These sources may cause the detector to perform erratically, giving numerous false signals.

*If the detector emits an overload sound, move the coil away from any large metal objects. Overloading is not harmful to the electronics of the detector.*

# 20 A Detecting Exercise

Before attempting to recover targets, it is important to understand how to interpret the audio signals of the detector.

- 1 Gather a collection of different metal objects, e.g. a nail, pull-tab, aluminium foil, various coins, gold and silver jewellery.
- 2 Remove all jewellery from your hands and wrists.
- 3 Take the detector outdoors, away from known electrical interference or metal objects. *If you are getting signals from a clear patch of ground, there could be buried metal objects. Try finding another area.*
- 4 Lay objects in a line, sufficiently spaced apart to allow the coil to pass between them, as shown. (pg. 21)
- 5 Turn the detector on, using the Threshold control. Turn the Threshold clockwise until it reaches a stable, audible 'hum'.
- 6 Switch the detector into Pinpoint/All Metals mode.
- 7 Turn the Sensitivity control clockwise to 5. The detector may produce signals with the coil motionless. These may not be target signals, but signals caused from the surrounding environment. You can overcome these false signals by reducing the Sensitivity. (*Sensitivity*, pg. 25)
- 8 Sweep the coil across the objects, one at a time, and observe the sounds of the detector as it detects each object.

The Excalibur II should 'beep' on every target. Large targets or targets close to the ground surface emit a louder signal.

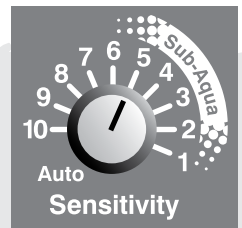

- 9 Switch the detector to Disc mode.
- 10 Turn the Discriminate control to 1.
- 11 Sweep the coil across the objects, one at a time, and observe the sounds.

Take note that as the coil is passed over the nail, the threshold 'hum' momentarily disappears (blanks), and then returns with a **lower** pitch. This indicates that a **ferrous** target is located underneath the coil, but has been rejected by you.

- 12 Whilst sweeping the coil across the objects, turn the Discriminate control progressively clockwise until the detector rejects the pull-tab.

Take note that as the coil is passed over the pull-tab, the threshold 'hum' momentarily disappears (blanks), and then returns with a **higher** pitch. This indicates that a **non-ferrous** target is located underneath the coil, but has been rejected by you.

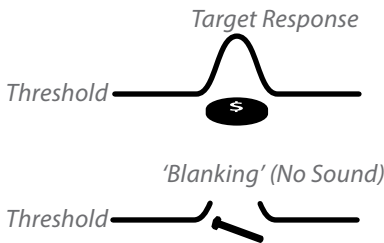
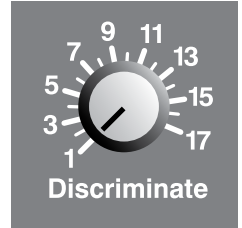

# 22 | **Threshold**

## Adjusting the Background Audio Level



Threshold is the constant audible background audio tone or 'hum' produced by the detector.

The level of the Threshold should be set low/to a minimum, but still audible and stable. Ideally it should be a smooth, gentle hum.

Small targets or large deep targets may not produce a distinct target signal, but may cause only a small variation in the threshold.

If the Threshold level is set too high or too low, these very small variations may be missed.

Listening for a target signal with a high threshold would be like trying to hear a whisper within a crowded noisy room. A high threshold level may also be uncomfortable for your hearing.

If the Threshold is set too low, the target signal needs to be loud enough to become audible, therefore very soft target signals from small or very deep targets may not be heard.

It is important to reset the Threshold level as conditions change. For example, your ears may adjust to the low levels of audio after an hour or so, or the conditions may have become windy.

Turn the Threshold control clockwise to increase the threshold level, or anti-clockwise to decrease the threshold level.



*When the threshold is too high, a faint signal is masked, and only the peak of the loud signal is audible above the Threshold.*

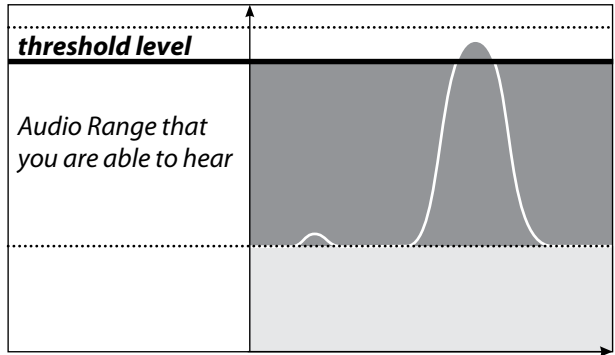

*With the threshold set correctly, both target signals are easily heard.*

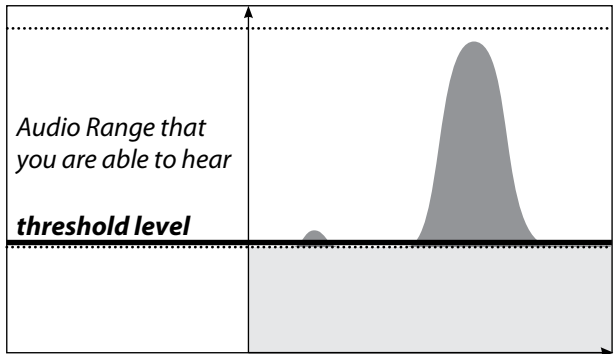

*A threshold level that is too low does not allow faint target signals to be heard.*

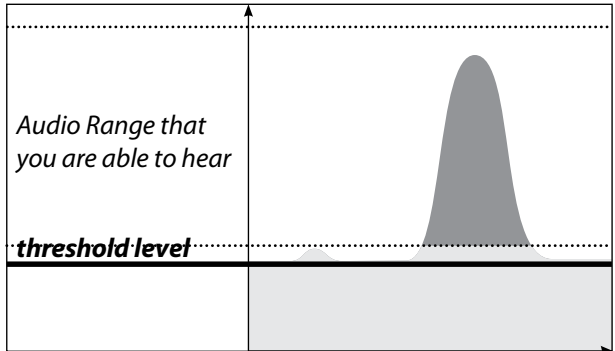

# 24 Volume

## Setting the Volume of Target Signals

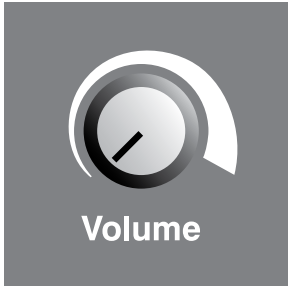

The Volume control is used to adjust target signal volume.

As you turn this control clockwise, the volume of target signals will increase.

At the most clockwise position, the volume is set at the maximum/loudest, position.

If the Volume control is set to maximum, all target signals will be heard and will sound proportional to the target size and depth. Maximum allows you to hear the difference between a small and large target, but may be uncomfortable to your hearing if a large target is found close to the coil.

A low volume will be more comfortable on your hearing, but you may risk missing small targets.

Try using a large and small target to adjust the volume to a comfortable level.



The detector is able to produce an extremely high volume if a large or shallow target is located.

**Protect your ears.**

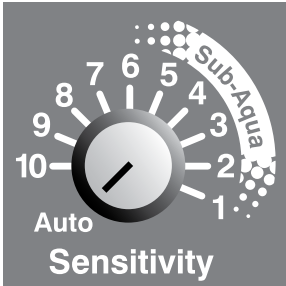

Sensitivity is the detector's level of response to its environment and to targets. The Sensitivity control allows you to adjust the level of sensitivity to suit the ground conditions in which you are detecting.

### **Auto**

At the most anti-clockwise position this control 'clicks' into the Auto position. In this setting the Excalibur II will automatically select its level of sensitivity to suit the detecting conditions. Auto Sensitivity is recommended when detecting areas of high or variable ground mineralisation.

### **Manual**

Turning the control clockwise will 'click' the Excalibur II out of Auto and into Manual sensitivity. 1 is minimum, 10 is maximum sensitivity.

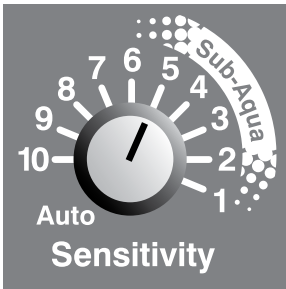

It is always recommended to adjust the manual sensitivity as high as possible without producing false signals. For example, turn the control anticlockwise until false signals are heard, then slowly adjust clockwise until the false signals 'just' stop. Setting the Excalibur II so that it is 'just' stable, will ensure maximum depth and sensitivity whilst still hearing faint signals. Set too high and increased noise may mask faint signals. Set too low and the detector may not hear faint signals.

The SUB AQUA gauge indicates the approximate level of Manual Sensitivity recommended when detecting underwater, on wet sand or concentrated black sand.

# 26 Identifying Targets

In order to identify different targets, the Excalibur II rates them along a scale. The conductivity and size of a target determines where it will appear on the scale.

**High-conductivity** targets, for example, a US quarter, Australian \$1 coin, 1£ coin or €.50 cent will produce a high pitch signal.

**Low-conductivity** targets, for example, small alloy coins, foil, 9 carat and fine jewellery, will produce a low pitch signal.

Pull-tabs, rings, and certain coins will produce an intermediate pitch depending upon the object's conductivity.

The size of objects will have some effect on the conductivity rating for targets. Generally, the larger the target, the higher the conductivity rating and the higher the pitch.

**Ferrous** targets contain a large amount of iron (e.g. iron nails or steel). Generally, ferrous objects are not wanted, so appear on the left side of the scale.

**Non-ferrous** targets have little or no iron content, such as pure gold, silver, copper and bronze. Generally non-ferrous targets are more valuable, so appear on the right end of the scale.



*Nail*



*Aluminium Foil*



*9K Gold Rings  
Some Coins*



*Pull-tabs*



*18K Gold Rings, Brass,  
Copper, Lead, Some Coins*

**Ferrous**

**Non-ferrous**

# Disc or Pinpoint/All Metals

## Selecting a Mode



The Excalibur II can operate in two different modes. This control selects either Disc (Discriminate) or Pinpoint/All Metals mode.

### **Disc (Discriminate)**

In Disc mode, the Discriminate control becomes active. The Discriminate control is used to ignore various ferrous objects. Typical ferrous objects encountered by treasure hunters are nails, screws, washers and bits of wire. These objects are generally not considered to be of value, so it is a distinct advantage to be able to ignore them while detecting. *(pg. 28)*



### **Pinpoint/All Metals**

In Pinpoint/All Metals mode, the detector will produce a sound on all metallic targets, detecting both ferrous and non-ferrous targets. In this mode the Discriminate control has no effect and the Excalibur II will respond with the same pitch to all types of metal.

The signal response in the Pinpoint/All Metals mode is much shorter than in Disc mode, making it easier to pinpoint the exact location of a target before digging. *(pg. 30)*

# 28 Discriminate

## Rejecting Unwanted Targets

In Disc mode, the Discriminate control becomes active. Discriminate allows you to reject or 'ignore' certain target signals while detecting.

### Low setting

With the Discriminate control set to 1, the Excalibur II will reject or 'blank' the threshold on ferrous metal objects while still accepting non-ferrous metal objects.





### High Setting

As you turn the Discriminate control further clockwise, objects with greater conductivity will be ignored, while objects of higher conductivity are still accepted.







Low Setting



 Nail	 Aluminium Foil	 9K Gold Rings Some Coins	 Pull-tabs	 18K Gold Rings, Brass, Copper, Lead, Some Coins
<b>Ferrous</b>		<b>Non-ferrous</b>		

High Setting



 Nail	 Aluminium Foil	 9K Gold Rings Some Coins	 Pull-tabs	 18K Gold Rings, Brass, Copper, Lead, Some Coins
<b>Ferrous</b>				<b>Non-ferrous</b>

You are also able to determine whether a rejected target was ferrous or non-ferrous by the pitch of the returning threshold after blanking. A rejected ferrous object will cause the returning threshold pitch to be a low tone, while a rejected non-ferrous object will cause the returning threshold pitch to be higher.

The Discriminate setting must be relative to the types of objects that you wish to hunt for and the amount of trash that you are prepared to detect. For example, if you are hunting for fine white gold rings and set the Discriminate control to position 4, you may also find some types of aluminium foil. If you do not want to dig old bottle caps but do want to dig brass buttons and copper coins, the Discriminate control should be set higher (approximately at number 13). Note however, that by doing this, most fine white gold rings, foil, and some yellow gold rings will also be ignored.

The two objects treasure hunters most commonly wish to ignore are aluminium foil and pull-tabs. These objects both cover a significant range on the Discriminate control. Setting the Discriminate control 'high' to eliminate all unwanted items will cause you to ignore a large range of valuable items. We recommend that you only discriminate the most common trash items, accepting the occasional unwanted target.

*As pull-tabs are made from various metallic alloys, their conductivity can vary. Discriminate control positions for pull-tabs may range between 11 and 15.*

### **Blanking**

Blanking is the silencing of the threshold when the coil is passed over a rejected target. Blanking is a useful way of distinguishing between wanted and unwanted targets.



If the Excalibur II produces a high-pitched rapidly pulsing sound while in Disc mode, the detector is being overloaded by a large piece of metal close to the coil. Raise the coil slightly above the ground and pass it over the area again to check the target. By lifting the coil away from the ground, the Excalibur II is able to detect the object accurately.

# 30 Pinpointing

## Locating the Target

The exact location of a target can be determined by Pinpointing.

Once the approximate target location is known:

- 1 Switch the detector to Pinpoint/All Metals mode.
- 2 Move the coil slowly over the target. The audio tone will increase in volume while moving towards the target and decrease in volume as you pass it. The tone will be loudest when the coil is directly over the target.

Quite often the detector will be producing its maximum volume for a broad area over the target. This generally indicates that the target is near the surface or is quite large.

- 3 Taking note of the response, reduce the span of each successive pass of the coil until you are confident of the location of the target. Make a mental note of the position, or mark a line on the soil with your shoe or a digging tool.
- 4 Move to one side so that you can pass the coil over the target at right angles to your initial direction. When the detector sounds you should know exactly where to dig. *(pg. 32)*





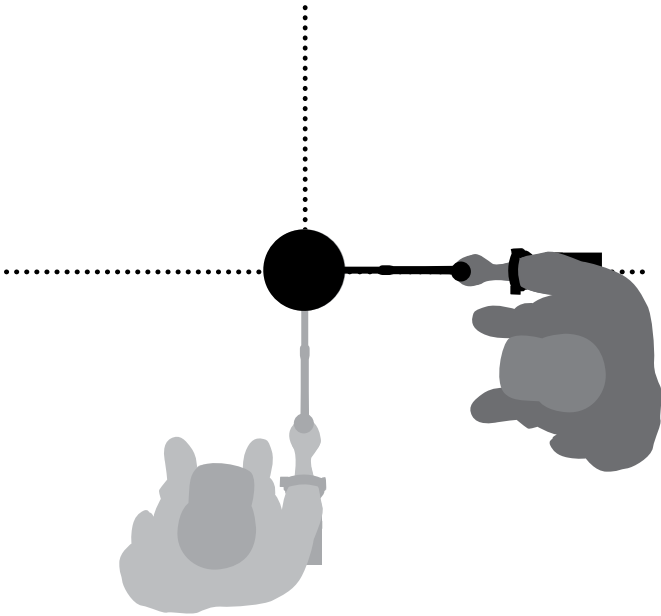

# 32 | Recovering the Target

It is essential to carry at least a small, strong digging spade, shovel or sand scoop with you when searching.

- 1 Clear the area of loose surface material and check that the target signal is still there. If it is not, the target should be amongst the moved surface material.
- 2 Take note if there are other signals close to your target. This is important so that when you come to dig your hole, you do not heap the loose sand/soil on top of another target already in the ground.
- 3 If the target signal is still present, use your spade to dig to a depth of approximately 50 mm (2").
- 4 Sweep the coil over the hole to determine if it has been dug. If the target signal is not heard, then the target should be in the material just removed. Otherwise dig a little deeper and check again.
- 5 Start digging approximately 100 mm (4") in front of the target to reduce the chance of damaging it. Damaging a target may reduce its value.
- 6 If the target signal disappears from the hole, sweep the coil over the loose sand/soil and pinpoint its exact position.

*When digging, avoid sharp edges to the hole as they can produce false signals, potentially masking the target. Slope the edges of the hole to avoid any problems.*

- 7 Put the detector down. Take a handful of the sand/soil and pass it over the coil.
- 8 If there is no signal, place the handful carefully in a new pile, pinpoint the position of the target again, and repeat with another handful of sand/soil.
- 9 Once the target is in your hand, transfer half of the sand/soil to the other hand. Test each handful across the coil.
- 10 If the target is too small to see, drop the sand/soil onto the top of the coil and with your finger move any suspect objects. A target signal will only be given when the target is moved.

*Your hands and wrists must be free of any metallic jewellery and watches when passing sand/soil over the coil.*



#### **Backfill Every Hole You Dig**

Always refill any holes on the land and beach before leaving the area. Help restore it to its original condition. Any rubbish you recover should be taken away with you and disposed of properly. Refilling holes and removing rubbish will help detector users maintain a good reputation. This should lead to more areas being readily accessible for detecting.

# 34 Taking Care of Your Detector



The Excalibur II is a high quality electronic instrument.

Take care of your detector in the following way:

- Visually check the lower end of both cylinders after entering the water. If any water droplets or condensation are visible inside your Excalibur II, turn it off and remove it from the water immediately. Remove your batteries and contact your Minelab dealer immediately.
- The battery and control cylinder have been sealed and pressure tested. Never open or tamper with the sealed electronics and battery cylinders, as this will void the warranty.
- If water or condensation is present in the end caps through the small screw, contact your Minelab dealer. If it appears outside the rubber O-ring seal it is OK.
- Avoid rapid changes in temperature. Gradual warming and cooling will keep the internal atmosphere stable. Extreme temperature swings may cause a light condensation to appear on the cylinder walls for a short time. Wait for this to disappear before using your Excalibur II.
- Never leave your Excalibur II in direct sunlight as it can reach very high temperatures, causing irreparable damage to your coil.
- Salt deposits, very fine sand, and grit will accumulate on the Excalibur II. Thoroughly rinsing your detector with fresh water after each use is necessary. Disconnect the shafts, battery pack, and armrest, and flush out all salt and sand, especially in the battery terminals. Also ensure that the vent holes on each headphone diaphragm are rinsed and clear of sediment. This is critical to allow for ear equalization when the Excalibur II is used for underwater detection at depth.

# Taking Care of Your Battery



- The NiMH battery pack has been sealed and pressure tested and should not be disassembled.
- Never allow the cables to be jerked or snagged. Excessive tension could cause the watertight seals or cable to fail.
- When disconnecting batteries, always grip the plug body, never the cable.
- As part of the manufacturing process, Minelab applies a silicone grease to the battery cable connector pins. This prevents a build-up of residual water and reduces the level of electrolysis between the two pins, which in turn prolongs the serviceability of your unit. This grease should be reapplied as part of your routine care and maintenance.
- It is recommended to recharge the battery every 3-6 months if not in regular use.
- Do not immerse the battery in any liquid when disconnected from the Excalibur II or allow water to enter.
- Do not use battery if there is condensation visible inside the battery pack.
- Do not use the battery if it is damaged or deformed.
- Do not charge the battery at temperatures above 30°C (86°F) or below 0°C (32°F).
- Do not leave the battery in hot environmental conditions (e.g. on the dashboard of your car or rear parcel shelf).
- Do not throw the battery or impact it in any way.
- Do not short-circuit the battery.
- Do not incinerate the battery.
- Return the battery to a Minelab authorised service centre for repair. The use of non-approved components will VOID YOUR WARRANTY. There are no user serviceable parts within this battery pack.

# 36 Troubleshooting

<b>No sound</b>	<ul style="list-style-type: none"><li>• Check that the detector is on. Try turning both the Threshold and Volume controls to maximum.</li><li>• Check that the battery pack and power cable are connected securely.</li><li>• Check that the battery is charged.</li><li>• Try using a different battery pack, available from your Minelab dealer.</li><li>• Check for breaks, cracks or extreme kinks in the cable assemblies.</li></ul>
<b>Erratic Noises</b>	<ul style="list-style-type: none"><li>• Reduce the Sensitivity by turning the control clockwise.</li><li>• Check that the battery is properly connected and fully charged.</li><li>• Switch Sensitivity to the Auto position.</li><li>• Check for sand or grit between the skid plate and coil.</li><li>• Check for overhead power lines and other sources of electrical interference.</li><li>• Check that the controls turn to the correct limits (marked on the decal). Also check that the 'clicks' are present on the Threshold, Disc, Pinpoint/All Metals and Sensitivity controls.</li></ul>

## Detector

Transmission	1.5, 3, 4.5, 6, 7.5, 9 ... 25.5 kHz
Technology	BBS - Broad Band Spectrum Technology Multiple Simultaneous Frequency
Coil (Standard)	8" or 10" Round Double D
Audio Output	Koss Headphones supplied - Impedance 8 $\Omega$
Length with standard shaft	Extended — 1220 mm (48") Retracted — 1140 mm (45")
Length with diving shaft	Extended — 910 mm (36") Retracted — 820 mm (32")
Weight (including NiMH battery)	Including 8" Coil — 2.1 kg (4.6 lbs) Including 10" Coil — 2.3 kg (5.1 lbs)

## Battery

Type	NiMH Battery Pack 1000 mAh (Alkaline optional)
Output Voltage	13 V when fully charged Max discharge current is 1 A
Capacity when fully charged	14–19 hours
Weight	0.3 kg (0.67 lbs)
Operating temperature range	0°C to 45°C (32°F to 113°F)
Storage temperature range	-20°C to 40°C (-4°F to 104°F)
Battery charge temperature range:	0°C to 30°C (32°F to 86°F)

# 38 | Accessories

The following items are also available for purchase.

- Alkaline Battery Pack Housing (batteries not included)
- Hipmount Kit
- Side-Mount Shaft Kit
- 12V Vehicle Charger
- Wingnut and Bolt Packs
- Teardrop Washers
- Black Skid Plate
- Yellow Skid Plate
- Blue Minelab Cap
- Blue Minelab Polo Shirt

For more information on these and other Minelab products call your Minelab dealer.



There is a one-year parts and labour warranty for the control box of the Excalibur II. Refer to your Warranty Card for more details. The Excalibur II BBS coil is warranted for one year. Refer to your supplier or Minelab for service, either in or out of warranty.

Note: This warranty is not transferable, nor is it valid unless the enclosed warranty registration card is returned to Minelab, or an authorized Minelab regional distributor, within 14 days of the original date of purchase.

The Minelab warranty does not cover damage caused by accident, misuse, neglect, alteration, modifications, or unauthorised service. For specific details of the Minelab warranty, refer to the 'Product Warranty Card'.



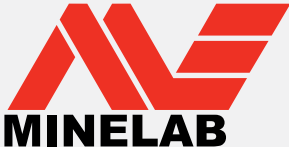

## The World Leader in Metal Detection Technology

*From our origins in 1985, Minelab have specialised in advanced electronics technologies. Our competitive advantage was created almost immediately with a highly competent and innovative Research and Development team, inspired by the genius of Mr. Bruce Candy.*

*This commitment to innovation has enabled us to successfully market feature-packed Consumer coin and treasure detectors enjoyed by hobbyists worldwide as well as high quality gold detectors used by both professionals and amateurs. Minelab's advanced technology is also incorporated in detection equipment designed for military and humanitarian de-mining projects throughout the world.*

*Today Minelab has manufacturing, distribution and customer service operations in Australia, Europe and the United States, and is an ISO 9001 Quality Endorsed Company. ISO 9001 is a worldwide quality standard certification that ensures the highest level of product quality for our customers.*

© Minelab Electronics Pty Ltd

This document contains proprietary information which is protected by copyright. Apart from any use as permitted under the Copyright Act 1968, no part may be reproduced by any process without written permission from Minelab Electronics Pty Ltd, 2 Second Ave, Mawson Lakes, SA 5095, Australia.

WARNING: This document contains Minelab Electronics Pty Ltd rights, technical data or restricted rights data, or both. Patents and trademarks apply.

**US Patent No's:** 5506506; 5537041.



### Working for a Cleaner, Greener Future

For Consumers within the European Union: Do not dispose of this equipment in general household waste.

The crossed out wheeled bin indicated on this equipment is an indicator that this unit should not be disposed of in general household waste, but recycled in compliance with local government regulations or environmental requirements.

Please dispose of this equipment via a recycling service or centre, or by returning the unit to the respective Minelab or Halcro outlet as appropriate for your unit. This will enable the equipment to be disposed of in an environmentally safe manner.

Disposal of unwanted electronic equipment in landfilled waste may contribute to adverse long term environmental effect due to the leaching of contaminating and toxic substances contained within some electronic equipment.

### Disclaimer:

The Minelab metal detector discussed in this operating manual has been expressly designed and manufactured as a quality hobbyist metal detector and is recommended for use in coin, treasure and general metal detection in non-hazardous environments. This metal detector has not been designed for use as a mine detector or as a live munitions detection tool.

### Please note:

Since there may be a variety of options available for this detector, equipment may vary according to the Model or items ordered with your detector. Certain descriptions and illustrations may also differ (in this manual) from the exact Model that you purchased. In addition, Minelab reserves the right to respond to ongoing technical progress by introducing changes in design, equipment and technical features at any time.

Item Number: 4901-0064-7

Minelab is always interested in your opinions. If you have any questions or comments regarding the Excalibur II or any other Minelab product, please feel free to contact us via your local Authorised Minelab dealer, or write to us:

**Minelab Electronics Pty. Ltd.**

**Australia & Asia Pacific**

☎ +61 8 8238 0888

✉ [minelab@minelab.com.au](mailto:minelab@minelab.com.au)

**Minelab Americas Inc.**

**North, South & Central America**

☎ +1 877 767 6522

✉ [info@minelabamericas.com](mailto:info@minelabamericas.com)

**Minelab International Ltd.**

**Europe & Russia**

☎ +353 21 423 2352

✉ [minelab@minelab.ie](mailto:minelab@minelab.ie)

**Minelab MEA General Trading LLC**

**Middle East & Africa**

☎ +971 4 254 9995

✉ [minelab@minelab.ae](mailto:minelab@minelab.ae)

**Minelab do Brasil**

**Brazil**

☎ +55 47 3406 3898

✉ [minelabdobrasil@minelab.com](mailto:minelabdobrasil@minelab.com)

For further product information and detecting tips, refer to: [www.minelab.com](http://www.minelab.com)